

itec 2,4,6,8 station AC Multi Program

INSTALLATION INSTRUCTIONS

Remove the lower cover. Place the unit on the wall using one slot and one fixed hole under the terminal. Connect the solenoid wires to the terminal block. One wire from each solenoid should be connected to C-Common. The other wire from each solenoid to its respective number on the terminal block. Connect the transformer wire to the terminal block. In outdoor units the transformer is already connected.

Only after all your wiring is done and checked, connect the 9 volt alkaline battery.

The 9 volt alkaline battery supplies the energy to run the "LOGIC" part of the circuit. During power failure, the program and the clock will continue to operate. Plug the transformer into a power outlet.

3 min. Automatic return to Auto-Run:
If for 3 min. the buttons are not pressed, the controller will return by itself to "AUTO-RUN/OFF" position. No Automatic return from "MANUAL" position.

To get to **Manual** mode from any position, press continuously.

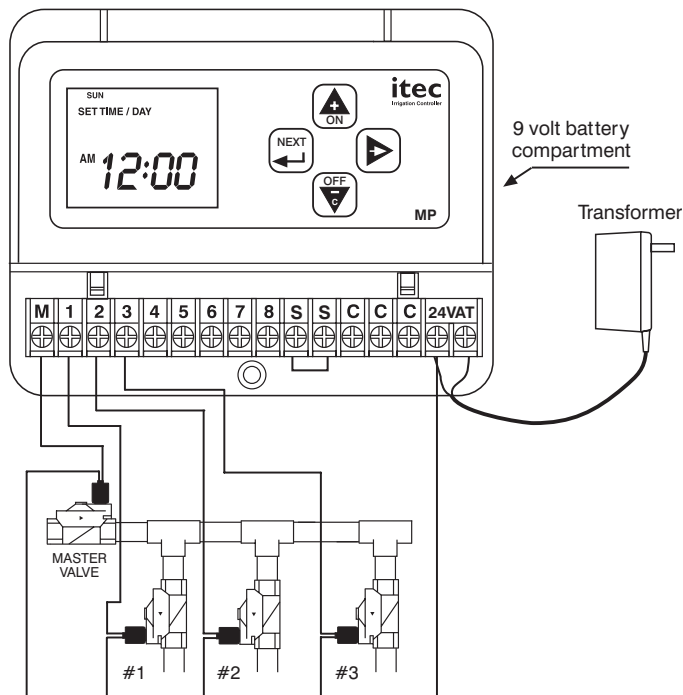

THE CONTROL PANEL

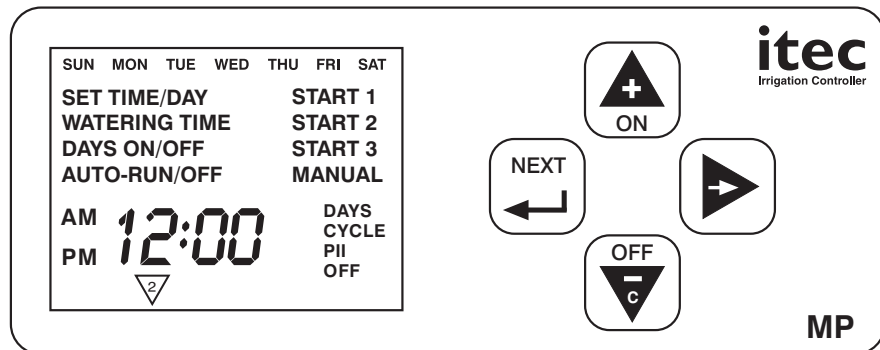

THE CONTROL BUTTONS

- NEXT STEP Advance to next programming step.
- Increase TIME & Watering Time. Used also as ON for Days ON & Manual ON.
- Advance Days & station No. In Watering Time position Will lead you to % scaling.
- COPY from previous station. Decrease TIME & Watering Time. Used also as OFF for Days OFF & Manual OFF.

DISPLAY ICONS

- Days of the week - upper line
- Programming Steps - Watering Time, Days On/Off, 3 start times Manual and Auto-Run
- 24V - Will flash if command to turn ON the station was given during Power Failure
- Days Cycle - Will be ON when programming Days Cycle
- OFF - RAIN OFF Icon
- Station No. Icon

IRRIGATION PROGRAM

This controller allows you to have an independent program for each station. Irrigation program consists of 3 parameters:

1 WATERING TIME Watering duration for each station **2** IRRIGATION DAYS Weekly calander or Days Cycle **3** START TIMES
You can program up to 3 starts per day.

If you wish to review all programming steps, simply press .
This will take you from one step to the next one and from one station to the next.

The station # icon  will be flashing throughout all programming steps of that station.

PROGRAMMING STEPS

NOTE If you press  or  continuously, the digits will advance quickly.

SET TIME/DAY After connecting the battery, the controller should display the "SET TIME/DAY" Icon.

If not, Press  until it is displayed.

Press  until current day is displayed. (Observe the days on the top of the display).



Press  or  to set current time AM or PM.

Please remember to use the fast advance mode.

1 Press  to enter the watering time step.

WATERING TIME Station #1 Icon is flashing and "OFF" is displayed = No Watering Time.
At this point you can enter the watering time or go to next station.

To select another station press  and follow the station # Icon.

Press  or  to set the watering time.



If you press  you start from 00:1 and going up.

If you press  you start from 9:59 and going down.

To reset watering time back to "OFF", press both  and  until "OFF" is displayed.

2 Press  to advance to next programming step.

DAYS ON/OFF You can select the days of the week or Days Cycle, from 1 = every day, to 30 = once every 30 days.

DAYS OF THE WEEK "SUN" is flashing. Press  if you wish to irrigate on SUN. Press  if you wish to skip SUN.

Once a button was pressed, "MON" will start flashing. Repeat the selection as above. The selected Irrigation Days will be displayed.

Press  to advance to next programming step.

DAYS CYCLE "SUN" or any other day is flashing.

Press  until display show "DAYS CYCLE" and "0 0".

The right digit will show the selected DAYS CYCLE.
The left digit will show the remaining days until the Irrigation Day.

Press  to select your DAYS CYCLE "1" - Irrigation every day.
"2" - Irrigation every 2nd day.
"3" - Irrigation every 3rd day.

NOTE The 1st day the controller will operate is the day you enter your program provided the selected start time was set to be AFTER programming was completed.

Selecting DAYS CYCLE will cancel any previous DAYS OF THE WEEK programming and vice versa.

If for example "2" was selected as DAYS CYCLE, the display will show "2 2" and at midnight it will change to "1 2" showing one day left. Above "19" the display will show remaining days as flashing "19".

Press  to advance to next programming step.

START TIME

Each station can be set to start 3 times per day. Make sure not to overlap one start with the next one as the controller will ignore it.
It is recommended to plan your irrigation schedule ahead of time.

START 1

Display show "OFF" = No start time. The station # Icon  is flashing.

To set START 1, Press  or .

TO RESET START 1 BACK TO "OFF"

Press  and  at the same time until "OFF" is displayed.

Press  to advance to START 2.

START 2

Display show "OFF" = No start time. To enter the time repeat as above.

Press  to advance to START 3.

NOTE It is necessary to enter at least one start time for the station to operate fully automatic.
If more then one start is not necessary, other two should remain in "OFF".

The programming of the flashing station is completed after start 3.

To advance to NEXT STATION Press .

Now the next station Icon is flashing and "WATERING TIME" is the current programming step.

If you wish to skip to another station, Press .

WAITING LIST CONCEPT

The controller will allow only 2 stations + master valve to be ON at the same time. If more then 2 stations were programmed to start at the same time, the 1st two will start and the others will be placed in the "WAITING LIST". As soon as one of the operating stations shut off, a station from the waiting list will start working until the end of the list.

THE COPY BUTTON

The "COPY" button can be used after the 1st station has been programmed. (Only in first programming)

The  button is used for this purpose.

When you enter "WATERING TIME" of station # 2, you can copy the watering time of station # 1.

When you enter "DAYS ON/OFF" of station # 2, you can copy the days of the week you selected for station # 1. Same for "DAYS CYCLE".

When you enter "START 1" of station # 2, you can copy the start 1 from station # 1 and the same for start 2 & start 3.

You can always change the copied number by using  or .

WATER BUDGET

When you wish to either increase or decrease watering time for ALL Programmed stations you can do it by using the Percentage Scaling method.

Your current setting of WATERING TIME represent 100%.

You can increase your watering time in increments of 10%, ie, 110%, 120% and up to 200%.

200% will double your current watering time.

You can decrease your watering time in increments of 10%, ie, 90%, 80% and down to 10%.

50% will reduce by half your current watering time.

You can get to WATER BUDGET position from any "WATERING TIME" -

Press  until you pass all station # Icons and 100 appears on the display.

Press  to increase watering time by percentage scaling.

Press  to decrease watering time by percentage scaling.

Press  to advance to "MANUAL OPERATION"

NOTE Only stations with programmed WATERING TIME can operate in manual or automatic modes.

SINGLE STATION MANUAL

You can turn on or shut off any selected station. When a station is ON, the station # Icon will be steady. If a station is left ON, it will shut off after it's set Watering Time.

From any programming position Press  continuously until "MANUAL"



Press  to turn ON and  to turn it OFF.

Press  to advance to next station.

Press  to advance to SEMI-AUTO operation.

SEMI-AUTO

Display show SEq = Sequential operation of ALL PROGRAMMED STATIONS

Press  to start the sequence. Press  if you wish to terminate it.

Press  to advance to AUTO-RUN/OFF position.

If the sequence is still running it will continue in the AUTO-RUN/OFF position.

Station # Icon will be displayed showing the current ON station.

AUTO-RUN/OFF

In AUTO-RUN/OFF position the current TIME and DAY will be displayed.

If any station is ON, it's Icon will be displayed as well.

RAIN-OFF

Rain-Off feature allows you to stop irrigation without changing the program. It applies to both Automatic operation as well as manual and semi-manual. You can at any desired time resume irrigation as was programmed. In AUTO-RUN/OFF position:

Press  to enter "RAIN OFF" mode. Notice the "OFF" Icon.

Press  to resume irrigation. The "OFF" Icon will disappear.

NOTE Do not disconnect the short wire on the sensor connection.

“ELECTRONIC FUSE”

Automatic short circuit detection and override

The controller detects a short circuit caused by defective solenoid or a short caused by the wires connecting the solenoid to the controller. As soon as the short is detected, that station only is turned off and the station # Icon together with "OFF" Icon will start flashing.

If the short is in the master valve then only "OFF" Icon will start flashing.

Verification of short circuit can be doen in "MANUAL" mode.





Press NEXT continuously to get to MANUAL. Here again the station Icon and "OFF" are flashing.

Press  to get to this station.

Press  to stop the flashing. Press  to start that station again.

If the flashing apeares once again, check your wiring to this station and if wire connection is fine, the cause of the short is the solenoid whichshould be replaced.

ALL PROGRAM ERASE - TOTAL RESET

In AUTO-RUN/OFF position Press ALL 4 keys     simultaneously.

After 2 seconds, all disply elements will appear. You can now release the keys. The entire irrigation program is now erased and the clock is reset to AM12:00 and SUN.

IMPORTANT INFORMATION

BATTERY REPLACEMENT

It is recommended to replace the 9 volt Alkaline battery every year, at the beginning of the irrigation season. Open the battery compartment and replace the battery. You have approx. 15 seconds to do it without losing the time and program.

NOTE Make sure you disconnect the transformer before replacing the battery. Connect it again after the new battery was connected.

POWER FAILURE INDICATION

If a station is due to turn on during a power failure the "24V" icon will start flashing. The "24V" will flash until next attempt, by any station, to turn on. If power is resumed by then, the flashing will stop.

PUMP START CONNECTION

It is recommended that the pump start connection will be done by licenced electrician. The Relay can be used to switch other things like Lights for example.

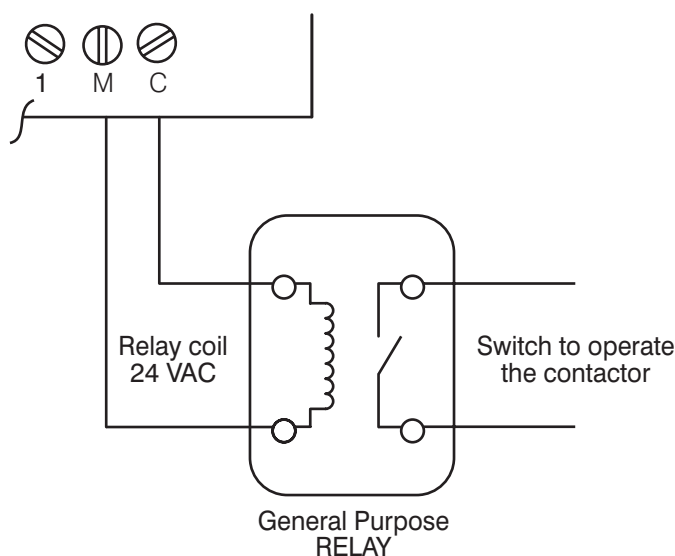

COPYRIGHT AND TRADEMARKS

The copyright in this document is held by I.T. Irrigation Systems Ltd. All material provided on this documents protected under United States copyright laws and international copyright laws and treaty provisions. Except as expressly provided herein, none of the materials provided on this documents may be copied, distributed, republished, reproduced, downloaded, displayed or transmitted in any form for commercial use without the prior written permission of I.T. Irrigation Systems Ltd. Individual visitors of this document permitted to download or print one copy solely for their personal, non-commercial use, provided that they do not modify the materials and that they retain all copyright and other proprietary notices contained in the materials. This permission terminates automatically if you breach any of the terms and conditions contained herein. I.T. Irrigation Systems Ltd. does not grant any express or implied right to you under any patents, trademarks, copyrights or trade secret laws. The trademarks, logos and service marks (collectively referred to as "Trademarks") displayed on this document are registered and unregistered Trademarks of I.T. Irrigation Systems Ltd. and no trademark license either express or implied is granted by I.T Irrigation Systems Ltd. You do not have any right to use any Trademark displayed on this document without prior written permission of I.T. Irrigation Systems Ltd. Trademarks are one of our most valuable business assets. In the event of unauthorized use or misuse of its Trademarks I.T. Irrigation Systems Ltd. will pursue its legal remedies without delay.